



EST.

1982

2W INTERNATIONAL

CONCERN FOR YOUR SAFETY

PRODUCT CATALOG >

HIGH VIZ PERSONAL PROTECTIVE EQUIPMENT

PUBLISHED
21



⚠ DANGER
Remaining aloft on full surface or near
panels and other openings may result
in severe injury or death.
Do not attempt to service the machine
the hot surface of the rear rollers.
Do not spray down or use high speed fans.

⚠ DANGER
**TURN POWER OFF
BEFORE SERVICING**

⚠
Hot surface.
Do not touch.
Do not touch.
DO NOT TOUCH.

26212

**SAFETY
FIRST**

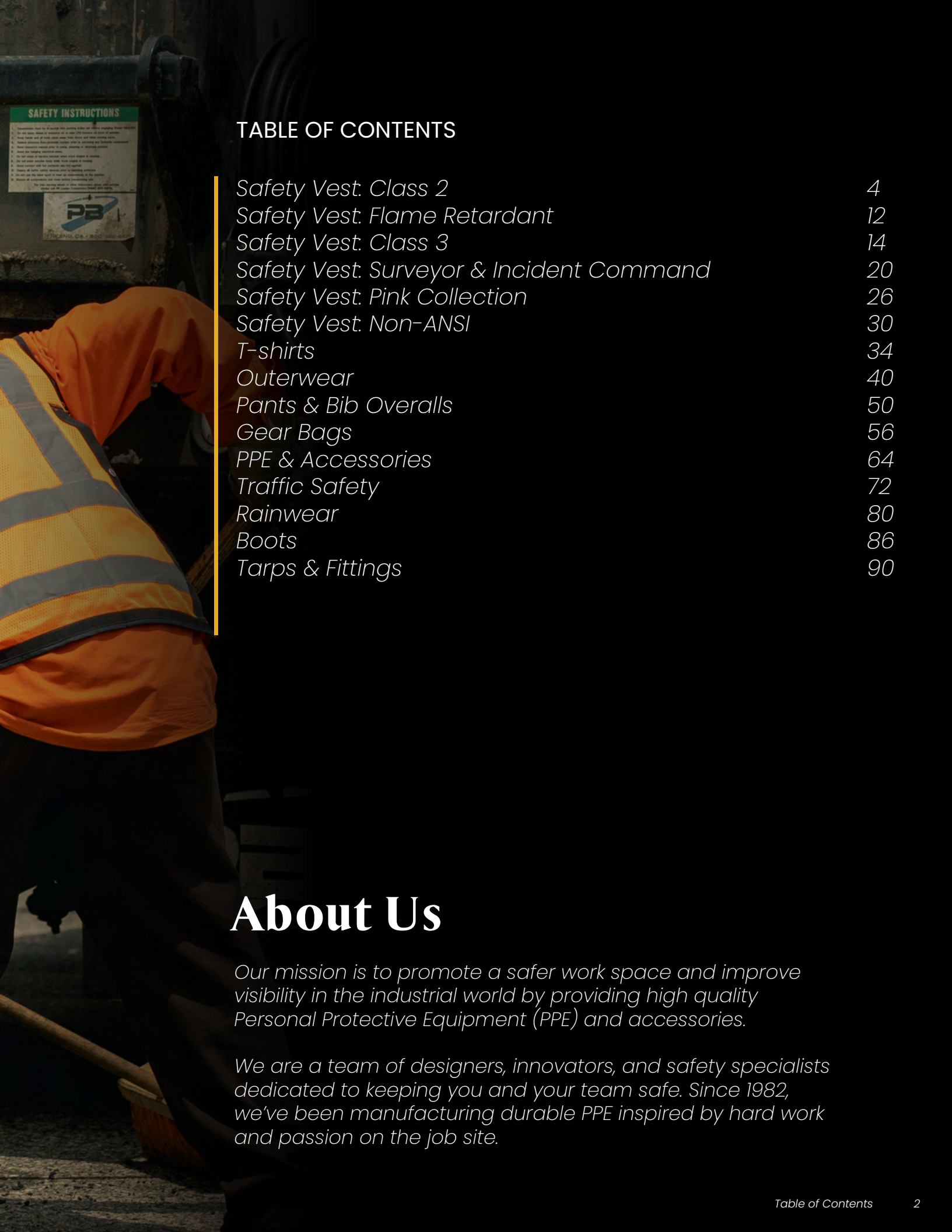

TABLE OF CONTENTS

<i>Safety Vest: Class 2</i>	4
<i>Safety Vest: Flame Retardant</i>	12
<i>Safety Vest: Class 3</i>	14
<i>Safety Vest: Surveyor & Incident Command</i>	20
<i>Safety Vest: Pink Collection</i>	26
<i>Safety Vest: Non-ANSI</i>	30
<i>T-shirts</i>	34
<i>Outerwear</i>	40
<i>Pants & Bib Overalls</i>	50
<i>Gear Bags</i>	56
<i>PPE & Accessories</i>	64
<i>Traffic Safety</i>	72
<i>Rainwear</i>	80
<i>Boots</i>	86
<i>Tarps & Fittings</i>	90

About Us

Our mission is to promote a safer work space and improve visibility in the industrial world by providing high quality Personal Protective Equipment (PPE) and accessories.

We are a team of designers, innovators, and safety specialists dedicated to keeping you and your team safe. Since 1982, we've been manufacturing durable PPE inspired by hard work and passion on the job site.

7038C-2





SAFETY VEST
CLASS 2

7038C-2 | 7048C-2

CONTRAST HI VIZ VEST



7038C-2



7048C-2

FABRIC 100% POLYESTER
SIZES M-5XL
COLORS LIME, ORANGE

Zipper front closure. 2" wide reflective stripes on 4" wide contrast color tape. 6 pockets total: 2 pen/tool pockets, 2 flap pockets and 2 inside pockets



A320C-2 | A520C-2

HI VIZ ECONOMY VEST



A320C-2



A520C-2



FABRIC 100% POLYESTER,
OPEN MESH WEAVE

SIZES M-5XL

COLORS LIME, ORANGE

Zipper front closure. 2" wide reflective stripes. 4 pockets total: 2 pen/cell phone pockets, 2 lower pockets for tools



M7038C-2 | M7048C-2

CONTRAST HI VIZ VEST



FABRIC 100% POLYESTER, OPEN MESH WEAVE

SIZES S-5XL (LIME), M-5XL (ORANGE)

COLORS LIME, ORANGE

Zipper front closure. 2" wide reflective stripes on 4" wide contrast color tape. 6 pockets total: 2 pen/tool pockets, 2 flap pockets and 2 inside pockets



M7038C-2



M7048C-2

MS330C-2 | MS530C-2

CONTRAST HI VIZ VEST



FABRIC 100% POLYESTER, MESH UPPER BODY AND SOLID LOWER BODY

SIZES M-5XL

COLORS LIME, ORANGE

Zipper front closure. 2" wide reflective stripes. 4 pockets total: 1 pen/tool pocket, 1 cell phone pocket and 2 lower flap pockets



MS330C-2



MS530C-2

MV327C-2 | MV529C-2

ECONOMY SAFETY VEST



FABRIC 100% POLYESTER, OPEN MESH WEAVE

SIZES S-5XL

COLORS LIME, ORANGE

Hook and loop front closure. 2" wide reflective stripes and contrast color piping. 2 pockets total: 1 chest pocket for pen/tool, 1 inside lower pocket



MV327C-2



MV529C-2

MZ327C-2 | MZ529C-2

ECONOMY SAFETY VEST



FABRIC 100% POLYESTER, OPEN MESH WEAVE

SIZES S-5XL
COLORS LIME, ORANGE

Zipper front closure. 2" wide reflective stripes and contrast color piping. 2 pockets total: 1 chest pocket for pen/tool, 1 inside lower pocket



MZ327C-2

MZ529C-2

B320C-2 | B520C-2

FIVE POINT BREAKAWAY VEST



FABRIC 100% POLYESTER, OPEN MESH WEAVE

SIZES M-5XL
COLORS LIME, ORANGE

Hook and loop closure on the front, sides, and shoulders for quick, breakaway removal with 2" wide reflective stripes, 1 inside lower pocket



B320C-2

B520C-2



FR M902C-2



EN320C-2 | EN520C-2

ONE SIZE FITS ALL HIGH VIZ VEST

ANSI
2
OF CLASS 2

FABRIC 100% POLYESTER, OPEN MESH WEAVE

SIZES ONE SIZE FITS ALL
COLORS LIME, ORANGE

Hook and loop front closure. 2" wide reflective stripes. 1" x 3" adjustable hook and loop strips on each side. 1 inside pen/tool pocket. Max width 56"



EN320C-2

EN520C-2

EN311C-2 | EN511C-2

LIGHT WEIGHT ECONOMY VEST

ANSI
2
OF CLASS 2

FABRIC 100% POLYESTER

SIZES S/M, L/XL, 2XL/3XL, 4XL/5XL*
COLORS LIME, ORANGE

Hook and loop front closure. 2" wide reflective stripes. 3 pockets total: 2 chest pockets for pens/tools, 1 lower patch pocket
*Combined sizing



EN311C-2

EN511C-2

MN321C-2 | MN521C-2

MINNESOTA HIGH VIZ VEST

ANSI
2
OF CLASS 2

FABRIC 100% POLYESTER, OPEN MESH WEAVE

SIZES M-5XL
COLORS LIME, ORANGE

Zipper front closure. Two 1" wide reflective stripes on 4.5" wide contrasting tape in split-trim design. 4 pockets total: 2 outside utility pockets and 2 pen/tool pockets



MN321C-2

MN521C-2

8138MC-2 | 8148YMC-2

ORALITE® HIGH VIZ VEST



FABRIC 100% POLYESTER, MESH UPPER BODY, SOLID LOWER BODY

SIZES M-5XL
COLORS LIME, ORANGE

Snap front closure. 2" wide Oralite® tapes. 4 pockets total: 2 flap gusset pockets and 2 pen/tool pockets



8138MC-2

8148YMC-2

8038GC-2 | 8048OC-2

ORALITE® HIGH VIZ VEST



FABRIC 100% POLYESTER

SIZES M-5XL
COLORS LIME, ORANGE

Zipper front closure. 1.5" wide Oralite® tapes. Mesh panel in the back for increased ventilation. 4 pockets total: 2 pen/tool pockets and 2 side slash pockets



8038GC-2

8048OC-2

DS325C-2 | DS525C-2

CONTRAST DOT STYLE VEST



FABRIC 100% POLYESTER, OPEN MESH WEAVE

SIZES S/M, L/XL, 2XL/3XL, 4XL/5XL*
COLORS LIME, ORANGE

*Zipper front closure with adjustable hook and loop sides. 2" wide reflective stripes on 4.5" wide contrasting tapes. 5 pockets total: 1 large radio pocket with badge tab, 2 chest pockets, and 2 inside pockets. *Combined sizing*



DS325C-2

DS525C-2

570ORC-2

SURV322C-2





FLAME RETARDANT

SAFETY VEST



FR M902C-2

FLAME RESISTANT SAFETY VEST



FABRIC 60/40 ANSI MODACRYLIC COTTON BLEND

SIZES M-4XL
COLORS LIME

Certified flame resistant fabric and reflective tape. Meets ASTM F1506-15 & ANSI 107-2020. Arc rating: ATPV 5.7 cal/cm2. NFPA 70E / HRC = 1. Hook and loop front closure. 2" wide reflective stripes. 1 lower inner pocket, 1 inner chest pocket

FR150C-2

FLAME RETARDANT VEST



FABRIC 100% POLYESTER, SOLID FRONT, OPEN MESH WEAVE BACK

SIZES M-5XL
COLORS LIME

Flame retardant meets ANSI 107-2010 and NFPA 701-2010 standards. Hook and loop front closure. 2" wide reflective stripes. 2 chest pockets

FR M7048C-2

FLAME RETARDANT HI VIZ VEST



FABRIC 100% POLYESTER, OPEN MESH WEAVE

SIZES S-5XL
COLORS LIME

Flame retardant meets ANSI 107-2010 and NFPA 701-2010 standards. Zipper front closure. 2" wide reflective stripes on 4" wide contrast color tape. 6 pockets total: 2 pen/tool pockets, 2 lower flap pockets, 2 lower inside pockets





SAFETY VEST
CLASS 3

MS339C-3 | MS539C-3

CONTRAST HI VIZ VEST



MS339C-3



MS539C-3

FABRIC 100% POLYESTER, MESH UPPER BODY, SOLID LOWER BODY

SIZES M-5XL

COLORS LIME, ORANGE

Zipper front closure. 2" wide reflective stripes. 4 pockets total: 1 pen/utility pocket, 1 cell phone pocket, and 2 lower flap pockets





570ORC-2

MS339C-3



7138C-3 | 7148C-3 **CONTRAST HI VIZ VEST**ANSI
3
OF JOB CERTIFIED

FABRIC 100% POLYESTER

SIZES M-5XL
COLORS LIME, ORANGE

Zipper front closure. 2" wide reflective stripes on 4" wide contrasting tape. 6 pockets total: 2 pen/tool pockets, 2 flap pockets and 2 inside pockets



7138C-3

7148C-3

M7138C-3 | M7148C-3 **CONTRAST HIGH VIZ VEST**ANSI
3
OF JOB CERTIFIED

FABRIC 100% POLYESTER, OPEN MESH WEAVE

SIZES M-5XL
COLORS LIME, ORANGE

Zipper front closure. 2" wide reflective stripes on 4" wide contrasting tape. 6 pockets total: 2 pen/tool pockets, 2 flap pockets and 2 inside pockets



M7138C-3

M7148C-3

S8138C-3 | S8148C-3 **PREMIUM ORALITE HIGH VIZ VEST**ANSI
3
OF JOB CERTIFIED

FABRIC 100% POLYESTER

SIZES M-5XL
COLORS LIME, ORANGE

Snap front closure. 2" wide Oralite® tapes. 4 pockets total: 1 pen/tool pocket, 1 cell phone pocket, and 2 flap gusset pockets



S8138C-3

S8148C-3

EN333C-3 | EN533C-3

LIGHT WEIGHT SAFETY VEST



FABRIC 100% POLYESTER

SIZES S/M, L/XL, 2XL/3XL, 4XL/5XL*

COLORS LIME, ORANGE

Hook and loop front closure. 2" wide reflective stripes.
3 pockets total: 2 chest pockets and 1 lower pocket
*Combined sizing



EN333C-3



EN533C-3

S8148C-3



THE WORLD IS UNPREDICTABLE...

**YOUR SAFETY GEAR
SHOULDN'T BE!**





SURVEYOR & INCIDENT COMMAND

SAFETY VEST

OPEN
TRENCH

A-3

IC113C-2 | IC115C-2 **CONTRAST INCIDENT COMMAND VEST**ANSI
2

FABRIC 100% POLYESTER

SIZES REGULAR OR JUMBO
COLORS LIME, ORANGE

Zipper front closure. Adjustable hook and loop side panels. 2" wide reflective stripes on 4.5" wide contrasting tape. Clear plastic card holders on front (3.5" x 5.5") and back (4.5" x 11.5"). 5 pockets total: 2 pen/tool pockets, 1 large radio pocket, and 2 inside pockets



IC113C-2

IC115C-2

IC113MC-2 | IC115MC-2 **CONTRAST INCIDENT COMMAND VEST**ANSI
2

FABRIC 100% POLYESTER, OPEN MESH WEAVE

SIZES REGULAR OR JUMBO
COLORS LIME, ORANGE

Zipper front closure. Adjustable hook and loop side panels. 2" wide reflective stripes on 4.5" wide contrasting tape. Clear plastic card holders on front (3.5" x 5.5") and back (4.5" x 11.5"). 5 pockets total: 2 pen/tool pockets, 1 large radio pocket, and 2 inside pockets



IC113MC-2

IC115MC-2

ICM103 | ICM105 **INCIDENT COMMAND VEST**ANSI
2

FABRIC 100% POLYESTER, OPEN MESH WEAVE

SIZES REGULAR OR JUMBO
COLORS LIME, ORANGE

Hook and loop front closure and elastic side closure. 1" wide reflective stripes on front and back. Clear plastic card holders on front (3.5" x 5.5") and back (4.5" x 11.5"). 2 pockets total: 1 right chest pocket, 1 inside patch pocket



ICM103

ICM105

IC100 INCIDENT COMMAND VEST



FABRIC 100% POLYESTER

SIZES REGULAR OR JUMBO

COLORS ORANGE, YELLOW, WHITE, RED, GREEN, BLACK, BLUE

Hook and loop front closure and elastic side closure. 1" wide reflective stripes on front and back. Clear plastic card holders on front (3.5" x 5.5") and back (4.5" x 11.5"). 2 pockets total: 1 right chest pocket and 1 inside patch pocket



IC100OR IC100LY IC100WT IC100RD IC100GR IC100BK IC100BL

IC110 CONTRAST INCIDENT COMMAND VEST



FABRIC 100% POLYESTER

SIZES REGULAR OR JUMBO

COLORS WHITE, RED, BLUE, BLACK, GREEN

Zipper front closure and adjustable hook and loop side panels. 2" wide reflective stripes on 4.5" wide contrast color tapes. Clear plastic card holders on front (3.5" x 5.5") and back (4.5" x 11.5"). 5 pockets total: 1 radio pocket, 2 pen/tool pockets, 2 inside pockets



IC110WT IC110RD IC110BL IC110BK IC110GR

CV-BK PREMIUM BLACK SAFETY VEST



FABRIC 100% POLYESTER, OPEN MESH WEAVE

SIZES S-5XL

COLORS BLACK

Zipper front closure. 2" wide reflective stripes with contrast cool gray trim. 1 large microphone or radio tab. 5 pockets total: 4 flap pockets, 1 clear flap pocket for ID badge



PWB503 HIGH VIZ PUBLIC SAFETY VEST



FABRIC 100% POLYESTER, OPEN MESH WEAVE

SIZES REGULAR OR JUMBO
COLORS GREEN, BLUE, RED

Hook and loop breakaway shoulders and sides. Two 1" wide reflective stripes on 4.5" wide contrasting tape in split design. 2 microphone or radio tabs. 2 pockets total: 1 pen/tool pocket, 1 cell phone/radio pocket



PWB503GR

PWB503BL

PWB503RD

PWB505 HIGH VIZ PUBLIC SAFETY VEST



FABRIC 100% POLYESTER, OPEN MESH WEAVE

SIZES REGULAR OR JUMBO
COLORS GREEN, BLUE, RED

Hook and loop breakaway shoulders and sides. 2" wide reflective stripes. 2 microphone or radio tabs. 2 pockets total: 1 pen/tool pocket, 1 cell phone/radio pocket



PWB505BL

PWB505RD

PWB505GR

SURV322C-2 | SURV522C-2 HIGH VIZ SURVEYOR VEST



FABRIC 100% POLYESTER, OPEN MESH WEAVE

SIZES M-5XL
COLORS LIME, ORANGE

Snap front closure. 2" wide reflective stripes and black piping. Grommets at neck and pockets for tools and lanyards. 7 pockets total: 1 pen/tool pocket, 1 radio/cell phone pocket, 1 large back pocket for map book with snap closure, 2 large front utility pockets, and 2 large inside pockets



SURV322C-2

SURV522C-2

SV544C-2 PREMIUM SURVEYOR VEST



FABRIC 100% POLYESTER, MESH UPPER BODY, SOLID LOWER BODY, FULL MESH BACK
SIZES S-5XL, PINK AVAILABLE IN XS-3XL ONLY
COLORS GREEN, PINK, RED, NAVY BLUE, BLACK, ROYAL BLUE

Zipper front closure with webbing reinforcement. 2" wide reflective stripes and reflective trims around arms. Left and right chest grommets. 2 mic tabs. Ultra-padded neck for enhanced comfort. 6 pockets total: 2 upper pockets: left hook and loop flap pocket for ID badge and two tier right chest pocket for pens/tools. 2 lower expandable flap pockets with grommets. 2 inside pockets: lower left has load bearing strap perfect for tablet or notebook



SV544GRC-2 SV544PKC-2 SV544RDC-2 SV544NVC-2 SV544BKC-2 SV544RBC-2

570C-2 CONTRAST TWO TONE VEST



FABRIC 100% POLYESTER, MESH UPPER BODY, SOLID LOWER BODY, FULL MESH BACK
SIZES S-5XL, PINK AVAILABLE IN XS-3XL ONLY
COLORS PINK, BLACK, ORANGE

Zipper front closure. 2" wide reflective stripes on 4" wide contrast color trim. 2 mic tabs. 6 pockets total: 1 clear ID flap pocket (4"x4"), 1 two tier chest pocket with pen/tool slots, 2 lower flap gusset pockets, 2 inside tablet pockets with load bearing straps



570PKC-2 570ORC-2 570BKC-2

550C-2 TWO TONE VEST



FABRIC 100% POLYESTER, MESH UPPER BODY, SOLID LOWER BODY, FULL MESH BACK
SIZES S-5XL, PINK AVAILABLE IN XS-3XL ONLY
COLORS PINK, ORANGE, BLACK

Zipper front closure. 2" wide reflective stripes. 1 mic tab. 5 pockets total: 1 clear ID flap pocket (4"x4"), 1 chest pocket with pen/tool slot, 2 lower pockets, 1 inside pocket



550PKC-2 550ORC-2 550BKC-2

A woman wearing a bright pink safety vest and a light-colored short-sleeved shirt is shown from the side, her hands resting on a large cardboard box. She has purple nail polish. The background is a blurred industrial or warehouse setting with various boxes and equipment. The text 'WOMEN IN PINK' is overlaid in large white letters, with 'PINK COLLECTION' in smaller yellow letters below it. A vertical yellow bar is to the left of the text.

WOMEN IN PINK

PINK COLLECTION



SV544PKC-2

PREMIUM SURVEYOR VEST



FABRIC 100% POLYESTER, MESH UPPER BODY, SOLID LOWER BODY, FULL MESH BACK
SIZES XS-3XL
COLORS PINK

Zipper front closure with webbing reinforcement. 2" wide reflective stripes and reflective trims around arms. Left and right chest grommets. 2 mic tabs. Ultra-padded neck for enhanced comfort. 6 pockets total: 2 upper pockets: left hook and loop flap pocket for ID badge and two tier right chest pocket for pens/tools. 2 lower expandable flap pockets with grommets. 2 inside pockets: lower left has load bearing strap perfect for tablet or notebook

570PKC-2

CONTRAST TWO TONE VEST



FABRIC 100% POLYESTER, MESH UPPER BODY, SOLID LOWER BODY, FULL MESH BACK
SIZES XS-3XL
COLORS PINK

Zipper front closure. 2" wide reflective stripes on 4" wide contrast color trim. 2 mic tabs. 6 pockets total: 1 clear ID flap pocket (4"x4"), 1 two tier chest pocket with pen/tool slots, 2 lower flap gusset pockets, 2 inside tablet pockets with load bearing straps

550PKC-2

TWO TONE VEST



FABRIC 100% POLYESTER, MESH UPPER BODY, SOLID LOWER BODY, FULL MESH BACK
SIZES XS-3XL
COLORS PINK

Zipper front closure. 2" wide reflective stripes. 1 mic tab. 5 pockets total: 1 clear ID flap pocket (4"x4"), 1 chest pocket with pen/tool slot, 2 lower pockets, 1 inside pocket

SB CL-PK

COLOR SAFETY VEST

FABRIC 100% POLYESTER

SIZES ONE SIZE FITS ALL

COLORS PINK, NAVY BLUE, ROYAL BLUE, BLACK, PURPLE



Hook and loop front closure and elastic waist bands. 2 clear pockets: front 5" x 5" pocket and 11" x 5" back pocket perfect for ID badge or other identification. 1 lower pocket. Contrasting silver trim over clear pockets



SB CL-NV

SB CL-RB

SB CL-BK

SB CL-PL

550PKC-2





A close-up photograph of a person's hand in a blue long-sleeved shirt resting on a red and grey safety vest. The vest has a grid-like pattern of reflective strips. The background is a blurred green forest.

NON-ANSI

SAFETY VEST

8038A | 8048A MULTI-POCKET SAFETY VEST

FABRIC 100% POLYESTER

SIZES S-5XL

COLORS LIME, ORANGE

Zipper front closure. 1" wide reflective stripes. 6 pockets total: 2 pen/tool pockets, 2 flap pockets, and 2 inside pockets



8038A

8048A

8038M | 8048M MULTI-POCKET MESH SAFETY VEST

FABRIC 100% POLYESTER, MESH UPPER BODY, SOLID LOWER BODY

SIZES M-5XL

COLORS LIME, ORANGE

Zipper front closure. 1" wide reflective stripes. 6 pockets total: 2 pen/tool pockets, 2 flap pockets, and 2 inside pockets



8038M

8048M

8038B | 8048B MULTI-POCKET SAFETY VEST

FABRIC 100% POLYESTER

SIZES M-5XL

COLORS LIME, ORANGE

Zipper front closure. 6 pockets total: 2 pen/tool pockets, 2 flap pockets, and 2 inside pockets



8038B

8048B

8018 ECONOMY MESH SAFETY VEST



FABRIC 100% POLYESTER MESH
SIZES ONE SIZE FITS ALL
COLORS ORANGE

Hook and loop closure with two vertical reflective stripes on both front and back (No reflective material for 8018D)



8028 ECONOMY MESH SAFETY VEST



FABRIC 100% POLYESTER MESH
SIZES ONE SIZE FITS ALL
COLORS LIME

Hook and loop closure with two vertical reflective stripes on both front and back (No reflective material for 8028D)



7518 | 7528 BLAZE PLASTIC SAFETY VEST



FABRIC 100% LIGHT WEIGHT PLASTIC
SIZES ONE SIZE FITS ALL
COLORS LIME, ORANGE

Tie closure and suitable for one time use. Sold in dozens only

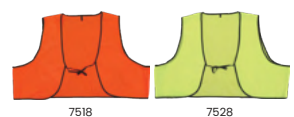



HIGH VISIBILITY
T-SHIRTS





Left chest pocket

2" wide solid reflective stripes

Breathable polyester that wicks away moisture



TB115C-3



TB113C-3

FABRIC 100% POLYESTER
SIZES S-5XL
COLORS LIME, ORANGE

Breathable polyester that wicks away moisture. One left chest pocket. 2" wide solid reflective stripes (heat pressed)



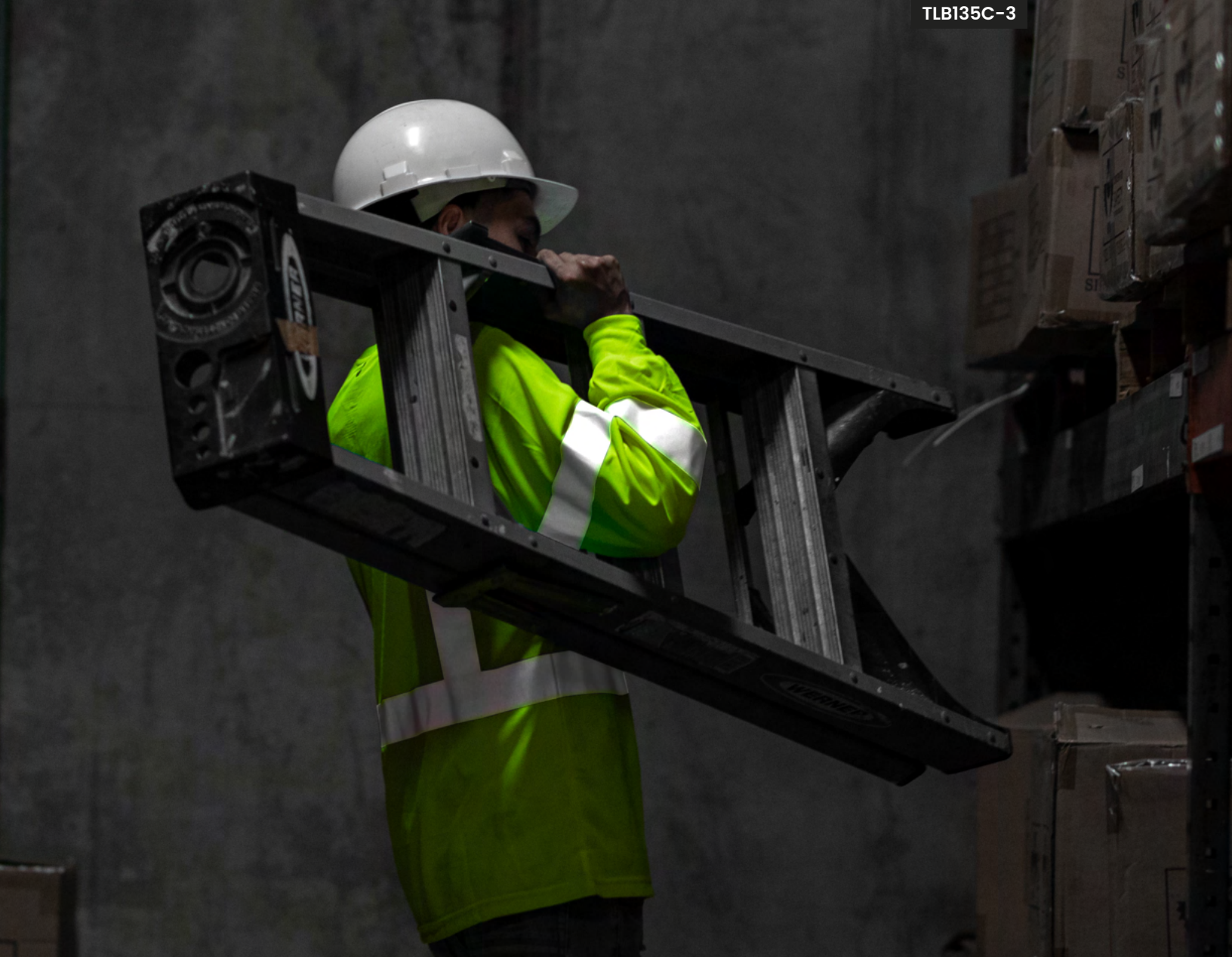

TLB133C-3 | TLB135C-3

HIGH VIZ LONG SLEEVE BIRDSEYE T-SHIRT



FABRIC 100% POLYESTER

SIZES S-5XL

COLORS LIME, ORANGE



Breathable polyester that wicks away moisture. One left chest pocket. 2" wide solid reflective stripes (heat pressed)



TLB133C-3

TLB135C-3

TB103C-2 | TB105C-2

HIGH VIZ SHORT SLEEVE BIRDSEYE T-SHIRT



FABRIC 100% POLYESTER

SIZES S-5XL
COLORS LIME, ORANGE

Breathable polyester that wicks away moisture. One left chest pocket. 2" wide solid reflective stripes (heat pressed)



TB103C-2

TB105C-2

TLB123C-2 | TLB125C-2

HIGH VIZ LONG SLEEVE BIRDSEYE T-SHIRT



FABRIC 100% POLYESTER

SIZES S-5XL
COLORS LIME, ORANGE

Breathable polyester that wicks away moisture. One left chest pocket. 2" wide solid reflective stripes (heat pressed)



TLB123C-2

TLB125C-2

TS103C-2 | TS105C-2

HIGH VIZ SHORT SLEEVE JERSEY T-SHIRT



FABRIC 100% POLYESTER

SIZES S-5XL
COLORS LIME, ORANGE

Breathable polyester that wicks away moisture. One left chest pocket. 2" wide segmented reflective stripes (heat pressed)



TS103C-2

TS105C-2



TL123C-2 | TL125C-2

HIGH VIZ LONG SLEEVE JERSEY T-SHIRTANSI
2
TYPE II

FABRIC 100% POLYESTER

SIZES S-5XL
COLORS LIME, ORANGE

Breathable polyester that wicks away moisture. One left chest pocket. 2" wide segmented reflective stripes (heat pressed)



TL123C-3

TL125C-3

TS113 | TS115

HIGH VIZ SHORT SLEEVE JERSEY T-SHIRT

FABRIC 100% POLYESTER

SIZES S-5XL
COLORS LIME, ORANGE

Breathable polyester that wicks away moisture. One left chest pocket



TS113

TS115

TL133 | TL135

HIGH VIZ LONG SLEEVE JERSEY T-SHIRT

FABRIC 100% POLYESTER

SIZES S-5XL
COLORS LIME, ORANGE

Breathable polyester that wicks away moisture. One left chest pocket



TL133

TL135





HIGH VISIBILITY
OUTERWEAR

330C-3 | 350C-3

HIGH VIZ REVERSIBLE BOMBER JACKET

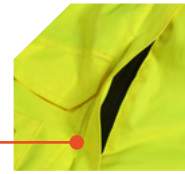

Detachable sleeves

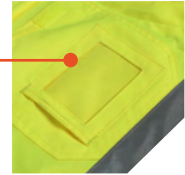

ID Badge holder

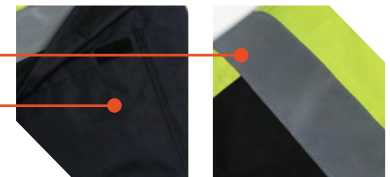

9 pockets total and 2" wide reflective stripes



330C-3



330C-3



350C-3 REVERSE SIDE



350C-3 REVERSE SIDE

FABRIC SHELL: 100% POLYESTER OXFORD WITH PU COATING
LINING: 65/35 POLY-COTTON DIAMOND QUILTED WITH POLY WADDING
300 DENIER

SIZES S-5XL

COLORS LIME/BLACK, ORANGE/BLACK

2" wide reflective stripes. Heavy duty zipper front closure. Rib knit waistband and cuffs. Detachable sleeves and hood with drawstring and stoppers. Reversible: Black interior. 9 pockets total: 1 chest flap pocket, 1 chest pocket with ID badge holder, 1 left sleeve pen/tool pocket, 2 handwarmer pockets, reverse side: 2 slash pockets, 2 chest pockets





230C-3 | 250C-3

HI VIZ LIGHT BOMBER JACKETANSI
3
HIGH VIZ

FABRIC SHELL: 100% POLYESTER OXFORD WITH PU COATING
LINING: 65/35 POLY-COTTON DIAMOND QUILTED WITH
POLY WADDING
300 DENIER

SIZES S-5XL
COLORS LIME/BLACK, ORANGE/BLACK

2" wide reflective stripes and 2 mic tabs. Heavy duty zipper front closure. Elastic waistband and cuffs with adjustable hook and loop straps. Detachable hood that rolls into collar with drawstring and stoppers. 5 pockets total: 1 clear ID pocket, 2 zipper pockets, 1 inner left chest pocket, and 1 left sleeve pen/tool pocket



230C-3

250C-3

300BC-2 | 300C-3

HI VIZ REVERSIBLE JACKET

FABRIC SHELL: 100% POLYESTER OXFORD WITH PU COATING
LINING: 65/35 POLY-COTTON DIAMOND QUILTED WITH
POLY WADDING
300 DENIER

SIZES S-5XL
COLORS LIME/ORANGE, ORANGE/BLACK

2" wide reflective stripes. Heavy duty zipper front closure. Rib knit waistband and cuffs. Reversible: Black interior. 9 pockets total: 1, left sleeve pen/tool pocket, 2 zipper slash pockets, 2 zipper chest pockets, Reverse side: 2 slash pockets, 2 chest pockets



300C-3

REVERSE SIDE

300BC-2

352C-3

PREMIUM HI VIZ JACKET WITH REMOVABLE LINING



FABRIC SHELL: 100% POLYESTER OXFORD WITH PU COATING
LINING: 65/35 POLY-COTTON DIAMOND QUILTED WITH POLY WADDING
300 DENIER

SIZES S-5XL
COLORS LIME/BLACK

2" wide reflective stripes. Heavy duty zipper front closure. Elastic waistband and cuffs with adjustable hook and loop straps. Hard hat friendly front flap on detachable hood that rolls into collar. Removable zip out lining. 9 pockets total: 2 large chest pockets, 2 handwarmer pockets, 1 right sleeve clear ID pocket, 1 left sleeve pen/tool pocket, 3 inner pockets

317C-3

HI VIZ LIGHT WEIGHT WINDBREAKER



FABRIC SHELL: 100% POLYESTER OXFORD WITH PU COATING
LINING: MESH
150 DENIER

SIZES S-5XL
COLORS LIME/NAVY BLUE

2" wide reflective stripes. Heavy duty zipper front closure. Rib knit waistband and cuffs. Water repellent fabric. Ventilated back flap with hook and loop closure. 3 pockets total: 2 side slash pockets, 1 chest cellphone pocket

SHL33C-3





SS23C-3 | SS25C-3

TWO TONE HOODIE SWEATSHIRT

ANSI
3

FABRIC 100% HEAVY WEIGHT 10 OZ. FLEECE POLYESTER

SIZES S-5XL

COLORS LIME/BLACK, ORANGE/BLACK

2" wide reflective stripes. Heavy duty zipper front closure. Rib knit waistband and cuffs. Attached hood with drawstring and stoppers. 2 handwarmer pockets



SS23C-3

SS25C-3

SSQZ25C-3

TWO TONE QUARTER ZIP SWEATSHIRT

ANSI
3

FABRIC 100% HEAVY WEIGHT 10 OZ. FLEECE POLYESTER

SIZES S-5XL

COLORS LIME/BLACK

2" wide reflective stripes. Stand up collar. Heavy duty quarter zipper front closure. Rib knit waistband and cuffs. 1 large handwarmer pocket

SHL33C-3 | SHL35C-3

HI VIZ SOFT SHELL JACKET

ANSI
3FABRIC SHELL: 100% SOFT SHELL THERMOPLASTIC POLYURETHANE
LINING: FLEECE

SIZES S-5XL

COLORS LIME/BLACK, ORANGE/BLACK

2" wide reflective stripes. Heavy duty zippers on front closure. Athletic cut and form fitting. Cord lock drawstring waist. Water repellent fabric. 2 mic tabs. 3 pockets total: 2 waist pockets with zipper, 1 chest pocket with zipper



SHL33C-3

SHL35C-3



FABRIC SHELL: 100% POLYESTER OXFORD WITH PU COATING
 LINING: 65/35 POLY-COTTON DIAMOND QUILTED WITH POLY WADDING
 300 DENIER

SIZES S-5XL

COLORS LIME/NAVY BLUE, ORANGE/NAVY BLUE

2" wide reflective stripes. Heavy duty zipper front and storm flap snap closure. Adjustable hook and loop straps on cuffs. Hard hat friendly attached hood with adjustable drawstring and stoppers. Reversible body warmer included. 14 pockets total: 6 on parka and 8 on body warmer. (See 736C-3 and 360VC-2 for details)





360VC-2 HI VIZ REVERSIBLE BODY WARMER



FABRIC SHELL: 100% POLYESTER OXFORD WITH PU COATING
 LINING: 65/35 POLY-COTTON DIAMOND QUILTED WITH POLY WADDING
 300 DENIER

SIZES S-5XL

COLORS LIME/NAVY BLUE

2" wide reflective stripes. Heavy duty zipper front closure. Reversible: Navy blue interior. 8 pockets total: 1 clear ID pocket, 1 chest cellphone pocket, 2 slash pockets. Reverse side: 2 zipper chest pockets, 2 patch pockets

733C-3 | 736C-3 HI VIZ RAIN PARKA



FABRIC SHELL: 100% POLYESTER OXFORD WITH PU COATING
 LINING: MESH
 300 DENIER

SIZES S-5XL

COLORS LIME/NAVY BLUE, ORANGE/NAVY BLUE

2" wide reflective stripes. Heavy duty zipper front and storm flap snap closure. Adjustable hook and loop straps on cuffs. Hard hat friendly attached hood with adjustable drawstring and stoppers. 6 pockets total: 1 clear ID pocket, 1 chest pocket with zipper, 2 two-way pockets with hook and loop closure, 2 inside pockets



733C-3

736C-3

730C-3 | 750C-3

HI VIZ RAIN JACKET



FABRIC SHELL: 100% POLYESTER OXFORD WITH PU COATING
LINING: MESH
300 DENIER
SIZES S-5XL
COLORS LIME, ORANGE

2" wide reflective stripes. Storm flap zipper front closure. Detachable hood with drawstring. Adjustable hook and loop cuffs. Underarm vents for breathability. 3 pockets total: 1 inside cellphone pocket, 2 flap pockets. 35" long



730C-3

750C-3

630C-3 | 650C-3

HI VIZ RAIN COAT



FABRIC SHELL: 100% POLYESTER OXFORD WITH PU COATING
LINING: MESH
300 DENIER
SIZES S-5XL
COLORS LIME, ORANGE

2" wide reflective stripes. Storm flap snap front closure. Double stitched and taped for waterproof. Detachable hood with drawstring. Adjustable hook and loop cuffs. Underarm vents for breathability. 3 pockets total: 1 inside cellphone pocket, 2 flap pockets. 49" long



630C-3

650C-3

155C-3

LIGHT WEIGHT HI VIZ RAIN JACKET



FABRIC SHELL: 100% POLYESTER OXFORD WITH PU COATING
LINING: MESH
150 DENIER
SIZES S-5XL
COLORS LIME

2" wide reflective stripes. Storm flap snap front closure. Double stitched and taped for waterproof. Detachable hood with drawstring. Cape ventilated back and underarm vents. Elastic inner cuffs. 2 flap pockets

736C-3



363C-3



730C-3





HIGH VISIBILITY

**PANTS AND
BIB OVERALLS**



737C-E

HIGH VIZ RAIN PANTS



FABRIC 100% POLYESTER OXFORD WITH PU COATING
300 DENIER

SIZES S-5XL

COLORS LIME/NAVY BLUE

2" wide reflective stripes. Boot zippers with adjustable hook and loop ankle straps. 2 pass-through slits for front pocket access. Elastic waistband with drawstring and cord locks



738C-E | 739C-E HIGH VIZ RAIN PANTS
ANSI
E
EN 15220:2005

FABRIC 100% POLYESTER OXFORD WITH PU COATING
 300 DENIER

SIZES S-5XL
COLORS LIME, ORANGE

2" wide reflective stripes. Boot zippers with adjustable hook and loop ankle straps. 2 pass-through slits for front pocket access. Elastic waistband with drawstring and cord locks



738C-E

739C-E

155P-E LIGHT WEIGHT HI VIZ RAIN PANTS
ANSI
E
EN 15220:2005

FABRIC 100% POLYESTER OXFORD WITH PU COATING
 150 DENIER

SIZES S-5XL
COLORS LIME

2" wide reflective stripes. Adjustable snaps on ankles. 2 pass-through slits for front pocket access. Elastic waistband with fly

MN322C-E | MN522C-E HI VIZ MINNESOTA PANTS
ANSI
E
EN 15220:2005

FABRIC 100% POLYESTER, OPEN WEAVE MESH

SIZES REGULAR, LONG, EXTRA LONG
COLORS LIME, ORANGE

Two 1" wide reflective stripes on 4.5" wide contrasting tape in split trim design. Elastic/draw cord with cord lock on waist. Elastic leg bands for safety and comfort. Provides comfortable and generous fitting as well as two pass-through slits for front pocket access



MN322C-E

MN522C-E

HBO77-E | HBO78-E

PREMIUM BIB OVERALL



FABRIC 100% POLYESTER OXFORD WITH PU COATING
300 DENIER
SIZES S-5XL
COLORS LIME/BLACK, ORANGE/BLACK

2" wide reflective stripes. Adjustable elastic suspenders with quick release buckles. Boot zippers. Adjustable hook and loop straps on waist and ankles. Snap fly closure. Waterproof with heat sealed seams. One flap pocket



HBO77-E

HBO78-E

HBO59-E

LIGHT WEIGHT BIB OVERALL



FABRIC 100% POLYESTER OXFORD WITH PU COATING
150 DENIER
SIZES S-5XL
COLORS LIME

2" wide reflective stripes. Adjustable elastic suspenders with quick release buckles. Adjustable hook and loop straps on waist and ankles. Waterproof with heat sealed seams

GMO-18 | GML-18

MESH HIGH VIZ GAITERS



GMO-18

GML-18

FABRIC 100% POLYESTER, OPEN MESH WEAVE
SIZES ONE SIZE FITS ALL
COLORS LIME, ORANGE

Two 2" wide reflective stripes (360 degree horizontal leg stripes). Adjustable top and bottom hook and loop closure for easy access and personalized fit. Black bottom prevents stains and helps keep clean appearance. Sold by pairs only

GWO-18 | GWL-18

WATERPROOF HIGH VIZ GAITERS



GWO-18

GWL-18

FABRIC 100% POLYESTER OXFORD WITH PU COATING
SIZES ONE SIZE FITS ALL
COLORS LIME, ORANGE

Two 2" wide reflective stripes (360 degree horizontal leg stripes). Adjustable top and bottom hook and loop closure for easy access and personalized fit. Black bottom prevents stains and helps keep clean appearance. Sold by pairs only



GB93-06





GEAR BAG
COLLECTION

BP63-01 | BP65-01

HIGH VIZ BACKPACK



BP63-01



BP65-01



FABRIC 900 DENIER POLYESTER ON PVC
SIZES 13.5" (W) X 9.5" (D) X 18.5" (H). 1.75 LBS.
COLORS LIME/BLACK, ORANGE/BLACK

High viz roomy backpack with 2" wide reflective trims for visibility. Comfortable, padded shoulder straps perfect for everyday use (adjustable from 17" to 30"). Features interior audio pocket with cord portal and sturdy web haul loop and ID pocket. Spacious, expandable mesh storage option in front of main compartment. Wet/dry storage option for both clean and soiled apparel. Comes with zip side pocket, water bottle holder, and ventilated shoe compartment. Packed 12 per case





GB95-01

LARGE WHEEL TURNOUT GEAR BAG

FABRIC 900 DENIER POLYESTER ON PVC UPPER, REINFORCED DOUBLE PVC COATED ON NYLON HARD BOTTOM

SIZES 32" (W) X 15" (D) X 15" (H). 7 LBS.

COLORS LIME/BLACK



Heavy duty in-line wheels and 3 bottom rails for weight support. Sturdy webbing handles with hook and loop closure and removable shoulder strap. ID pocket and reflective trims for increased visibility. 3 Large ventilated compartments and 2 zip pockets for easy storage and transportation. U-shaped, heavy duty zip opening at top for main compartment. Packed 4 per case

GB95-02 TURNOUT GEAR BAG

FABRIC 900 DENIER POLYESTER ON PVC UPPER, REINFORCED DOUBLE PVC COATED ON NYLON BOTTOM

SIZES 32" (W) X 15" (D) X 15" (H). 3.5 LBS.

COLORS LIME/BLACK

Sturdy webbing handles with hook and loop closure and removable shoulder strap. ID pocket and reflective trims for increased visibility. 3 large ventilated compartments and 2 zip pockets for easy storage and transportation. U-shaped, heavy duty zip opening at top for main compartment. Packed 6 per case

GB95-03 STEP-IN TURNOUT GEAR BAG

FABRIC 900 DENIER POLYESTER ON PVC UPPER, REINFORCED DOUBLE PVC COATED ON NYLON BOTTOM

SIZES 17" (W) X 18" (D) X 20" (H). 3.25 LBS.

COLORS LIME/BLACK

"Step in" style gear bag for quick jump in and suit up. Sturdy webbing handles with hook and loop closure and removable shoulder strap. ID pocket and reflective trims for increased visibility. Zip around closure compartment with 4 ventilation holes and 2 outside pockets. Packed 12 per case

GB95-04 BASIC GEAR BAG

FABRIC 900 DENIER POLYESTER ON PVC UPPER, REINFORCED DOUBLE PVC COATED ON NYLON BOTTOM

SIZES 22" (W) X 12.5" (D) X 12" (H). 2 LBS.

COLORS LIME/BLACK

Sturdy webbing handles with hook and loop closure and removable shoulder strap. ID pocket and reflective trims for increased visibility. Single compartment with 2-way wrap zipper for gear storage and transportation. Outside zip pocket for gloves and other small items. Packed 12 per case



GB95-06

DELUXE GEAR BAG



FABRIC 900 DENIER POLYESTER ON PVC UPPER, REINFORCED DOUBLE PVC COATED ON NYLON HARD BOTTOM
SIZES 19.5" (W) X 10.5" (D) X 15" (H). 3.4 LBS.
COLORS LIME/BLACK

Sturdy webbing handles with hook and loop closure and removable shoulder strap. ID pocket and reflective trims for increased visibility. Wide mouth framed opening at top for easy access. 2 exterior zip pockets and 2 interior zip slash wall pockets. Packed 6 per case



GB95-07

OUT OF COUNTY GEAR BAG



FABRIC 900 DENIER POLYESTER ON PVC
SIZES 15" (W) X 10" (D) X 23" (H). 3 LBS.
COLORS LIME/BLACK

Designed for short term missions/vacations. Sturdy webbing handles and removable shoulder strap. Large main compartment with heavy duty 2-way zipper and buckle adjustment. 3 exterior zip pockets for additional storage space and 1 back pocket for padded shoulder straps when not in use. Packed 6 per case



GB65-01

PUSH PACK BAG



FABRIC 900 DENIER POLYESTER ON PVC
SIZES 11" (W) X 4" (D) X 8" (H). 1.25 LBS.
COLORS LIME/BLACK

Multi-functional, hands-free storage bag with adjustable leg straps. Foam padding on back provides extra comfort and eases pressure. Reflective trim enhance visibility. Roomy main compartment with wall pockets for extra organization. 3 exterior zip pockets to place necessities at your fingertips. 2 expandable, mesh zip pockets hidden on each side for water bottles or flashlights. Multiple exterior webbing belts to hold small tools, pens or misc. items. Packed 12 per case

GB93-02 TURNOUT GEAR BAG

FABRIC 900 DENIER POLYESTER ON PVC UPPER, REINFORCED
DOUBLE PVC COATED ON NYLON BOTTOM

SIZES 32" (W) X 15" (D) X 15" (H). 3.5 LBS.

COLORS ORANGE/BLACK

Sturdy webbing handles with hook and loop closure and removable shoulder strap. ID pocket and reflective trims for increased visibility. 3 large ventilated compartments and 2 zip pockets for easy storage and transportation. U-shaped, heavy duty zip opening at top for main compartment. Packed 6 per case

GB93-04 BASIC GEAR BAG

FABRIC 900 DENIER POLYESTER ON PVC UPPER, REINFORCED
DOUBLE PVC COATED ON NYLON BOTTOM

SIZES 22" (W) X 12.5" (D) X 12" (H). 2 LBS.

COLORS ORANGE/BLACK

Sturdy webbing handles with hook and loop closure and removable shoulder strap. ID pocket and reflective trims for increased visibility. Single compartment with 2-way wrap zipper for gear storage and transportation. Outside zip pocket for gloves and other small items. Packed 12 per case

GB93-06 DELUXE GEAR BAG

FABRIC 900 DENIER POLYESTER ON PVC UPPER, REINFORCED
DOUBLE PVC COATED ON NYLON HARD BOTTOM

SIZES 19.5" (W) X 10.5" (D) X 15" (H). 3.4 LBS.

COLORS ORANGE/BLACK

Sturdy webbing handles with hook and loop closure and removable shoulder strap. ID pocket and reflective trims for increased visibility. Wide mouth framed opening at top for easy access. 2 exterior zip pockets and 2 interior zip slash wall pockets. Packed 6 per case

FM-7220 HALF FACE RESPIRATOR BAG



FABRIC POLYESTER ON PVC
SIZES 8.5" (H) X 7.5" (W) X 3.5" (D)
COLOR BLACK, BLUE

Heavy duty belt loops for fast access. Hook and loop closure. Pocket for ID or name card. Black carrying belt (Item # FM-7500) sold separately. Pack 50 per case

FM-7440 FULL FACE RESPIRATOR BAG



FABRIC POLYESTER ON PVC
SIZES 11.5" (H) X 7.5" (W) X 5.5" (D)
COLOR BLACK, BLUE, GREEN, GRAY, RED

Heavy duty belt loops for fast access. Hook and loop closure. Pocket for ID or name card. 2 side pockets with hook and loop closure. Black carrying belt (Item # FM-7500) sold separately. Pack 50 per case

FM-7500 ADJUSTABLE CARRYING BELT



FABRIC 100% POLYESTER WEBBING
COLOR BLACK

Carrying belt for FM-7220 and FM-7440. Quick release buckle. Adjustable length. Pack 50 per case



A close-up, low-angle shot of a person's lower body and legs as they walk on a paved road. The person is wearing an orange t-shirt and white pants. They are stepping over a black speed bump with yellow reflective stripes. The background is a blurred asphalt road and a building with a yellow and black striped pole.

PPE AND ACCESSORIES

KCO-11 | KCL-12

HIGH VIZ KNITTED CAP



KCO-11



KCL-12

FABRIC 100% ACRYLIC

SIZES ONE SIZE FITS ALL
COLORS LIME, ORANGE

Soft blended knit with embroidered "owl" logo

KCO-11R | KCL-12R

HIGH VIZ KNITTED CAP WITH REFLECTIVE TRIMS



KCO-11R



KCL-12R

FABRIC 100% ACRYLIC

SIZES ONE SIZE FITS ALL
COLORS LIME, ORANGE

Soft blended knit with 2 silver reflective trims

SUNHAT

HIGH VIZ SUNHAT



FABRIC 100% POLYESTER

SIZES ONE SIZE FITS ALL
COLORS LIME

Adjustable hook and loop strip on back. Reflective trims. Snap-on buttons for ventilation. Large panel to protect ears and neck. ANSI certified fabric with UV protection. Neck Strap with stoppers



FABRIC 100% POLYESTER, OPEN MESH WEAVE

SIZES ONE SIZE FITS ALL

COLORS LIME, ORANGE



HSO-11

HSL-12

Contrasting trim with reflective stripes. Elastic headband with hooks. ANSI certified fabric with UV protection. Fits cap/full brim style hard hats



NPS01

CLASSIC SOFT KNEE PAD



MATERIAL 600D POLYESTER, EVA FOAM BODY

SIZES ONE SIZE FITS ALL
COLORS ORANGE/BLACK

Light weight and comfortable. Dual adjustable hook and loop closure for easy wear. Ideal for kneeling on delicate surfaces or gardening

NPH02

HARD CAP KNEE PAD



MATERIAL 600D POLYESTER, EVA FOAM BODY, HARD PE CAP

SIZES ONE SIZE FITS ALL
COLORS BLACK

Dual adjustable hook and loop closure for easy wear and maximum comfort. Suitable for rocky or hard surfaces

NPH03

HEAVY DUTY KNEE PAD



MATERIAL 600D POLYESTER, HIGH DENSITY EVA FOAM BODY, HARD PE CAP

SIZES ONE SIZE FITS ALL
COLORS ORANGE/BLACK

Full-size, hard cap knee pad. High density EVA foam provides maximum comfort and support. Long hard-cap for extra protection and dual adjustable hook and loop closure for easy wear. Suitable for rough and tough environments or terrains

NPS04

GEL CAP KNEE PAD



MATERIAL 600D POLYESTER, HIGH DENSITY EVA FOAM BODY, SOFT PVC GEL-CAP

SIZES ONE SIZE FITS ALL
COLORS ORANGE/BLACK

Full-size, gel-injected cap knee pad. High density EVA foam and gel cap absorbs impact and provides maximum comfort and support. Hook and loop neoprene strap closure. Suitable for rough and tough environments or terrains

KP2311 KNEELING PAD



MATERIAL HIGH DENSITY EVA FOAM

SIZES 23" X 11" X 1"
COLOR BLACK

1" thick foam provides maximum comfort and support when seated or kneeling

BSB3400 ELASTIC BACK SUPPORT BELT



FABRIC 100% POLYESTER

SIZES S-4XL
COLORS BLACK

Belt has 4" double closure. Outer pull panels for more personalized fit and extra lower back support. 8" cool elastic back panel provides maximum ventilation. 4 internal stays with anti "ride-up" rubber webbing keeps the belt where it belongs. 1.25" wide detachable suspenders

BSB3500HY HIGH VIZ ELASTIC BACK SUPPORT BELT



FABRIC 100% POLYESTER

SIZES S-4XL
COLORS ORANGE/BLACK

Belt has 4" double closure. Outer pull panels for more personalized fit and extra lower back support. 8" cool elastic back panel provides maximum ventilation. 4 internal stays with anti "ride-up" rubber webbing keeps the belt where it belongs. 1.25" wide detachable suspenders

SBC-18 HIGH VIZ SEAT BELT COVER



FABRIC 100% POLYESTER

SIZES ONE SIZE FITS ALL, 18" LONG
COLORS LIME/ORANGE

Standard size seat belt cover fits any car or truck. Two 2" wide reflective trims with hook and loop closure on ANSI certified fabric

AMB-PK ARMBAND ID BADGE HOLDER



MATERIAL SOFT PVC, 100% POLYESTER WEBBING

SIZES ONE SIZE FITS MOST
COLORS BLACK, LIME YELLOW, PINK, ORANGE

Vertical layout. Holds a standard credit card size photo ID. Adjustable band with hook and loop strip for easy removal. Waterproof zip lock seal. Contains no metal-metal detector friendly



AMB-OR AMB-LY AMB-BK

RS-16 REFLECTIVE HELMET STICKER



MATERIAL MICROPRISMATIC REFLECTIVE VINYL

SIZES STICKER DIMENSIONS: 4" X 1"
SHEET DIMENSIONS: 9" X 9"

COLORS LIME YELLOW, BLUE, WHITE, RED-ORANGE

16 stickers per sheet



RS-16 LY RS-16 BL RS-16 WT RS-16 RO

CT-1330 COOLING TOWEL



FABRIC POLYVINYL ACETATE (PVA)

SIZE 13" X 30"

COLORS BLUE

Ultra absorbent material for long periods of water retention. Longer lasting cooling than many standard fabrics. Anti-microbial treated fabric to prevent mold and bacterial growth. Reusable and machine washable

HSB-03 | HSB-50 | HSB-100 HARD HAT SWEAT BAND



FABRIC 100% COTTON TERRY CLOTH

SIZES ONE SIZE FITS MOST

COLORS WHITE

Snap closure. Absorbent and comfortable. Machine washable. Comes in 3 pack, 50 pack, and 100 pack





FS-7005

HIGH QUALITY FACE SHIELD**MATERIAL** 0.25 MM OPTICALLY CLEAR PET**SIZES** 13" W X 8" L

Perforated open cell foam design for comfort. Light weight with soft stretchable elastic band. Anti-fog and anti-static on both sides. Reusable and easily cleaned. Full face protection. Fits over most eyeglasses

3547

0.35MM HEAVY DUTY APRON**FABRIC** PVC REINFORCED WITH STRONG POLYESTER NET BACKING**SIZES** 35" W X 47" L**COLORS** YELLOW

Self-material neck strap with buckle for easy on and off

2551

0.35MM SPLIT LET CHAP APRON**FABRIC** PVC REINFORCED WITH STRONG POLYESTER NET BACKING**SIZES** ONE SIZE FITS ALL**COLORS** YELLOW

Adjustable straps with buckles on neck, waist and legs. Open crotch/split leg design protects legs and clothing against stains and moisture. Heat-sealed guideline for easy cut off to adjust chap length





**TRAFFIC
SAFETY**

1850 | 1855

TRAFFIC SAFETY PADDLE



1850

1855

MATERIAL LIGHT WEIGHT ABS MATERIAL WITH 5" PLASTIC HANDLE, NON REFLECTIVE

SIZES 18" OCTAGON SHAPE, 6" LETTER SIZE

Paddle handle fits standard threaded tip on utility handle or extension pole available in most hardware stores (Patent pending)

1860E | 1865E

ENGINEERING GRADE TRAFFIC SAFETY PADDLE



1860E

1865E

MATERIAL LIGHT WEIGHT ABS MATERIAL WITH 5" PLASTIC PADDLE, EG REFLECTIVE

SIZES 18" OCTAGON SHAPE, 6" LETTER SIZE

Paddle fits standard threaded tip on utility handle or extension pole available in most hardware stores (Patent pending). Meets MUTCD standard

BAO-11 | BAL-12

LIGHT WEIGHT TRAFFIC BATON



MATERIAL ABS HANDLE, PE TOP CONE

SIZE 12" LONG, 1" DIAMETER, 6" TOP CONE

COLORS LIME/BLACK, ORANGE/BLACK

Durable baton is shock, weather, and water resistant. Contains anti-roll base with attached lanyard. Lighting function: flashing/steady. Requires 2 "C" batteries (not included)

BA-16

HIGH INTENSITY, LED TRAFFIC BATON WITH FLASHLIGHT



MATERIAL RUGGED POLYCARBONATE REFLECTOR LENS AND ABS HANDLE

SIZES 17.5" LED BATON
COLORS RED/BLACK

Pulsating 17.5" red LED baton comes with 5 high intensity white LED lights. Strong magnetic bottom and is weather, water and impact resistant. Lighting function: fast red flash/red steady, and white flashlight function. Includes belt clip and strap. Requires 2 "C" batteries (not included)

DW16-T | DW16-R

DAY WAND



MATERIAL HDPE WITH UV INHIBITORS

SIZES 16" LONG

COLOR ORANGE

Used for directing vehicles, aircrafts, and crowds during daylight hours. Round tube (DW16-R) comes with "self stick" hook & loop to prevent rolling. Sold in pairs only

AW-340 | AW-540

LOUD AND FAR SAFETY WHISTLE



AW-340

MATERIAL HIGH VIZ DURABLE ABS MATERIAL

COLORS LIME, ORANGE

Pealess whistle has 3 chambers for high pitch sound. Weather and water resistant. Includes lanyard with adjustable slider and breakaway clasp



AW-540

CCAD

HIGH VIZ CONE CADDY



FABRIC DOUBLE PVC COATED ON NYLON
SIZES FITS UP TO 36" SAFETY CONE
COLOR ORANGE

Cone caddy designed to slip easily over safety cone. 4" wide ANSI approved reflective tape, 6 total pockets with eyelet on each pocket for drainage purpose

WS-1036

WINDSOCK



FABRIC 100% NYLON
SIZES 10" THROAT, 36" LONG
COLORS ORANGE

UV treated material. Light weight for easier wind detection. 10 rust-proof grommets for easy mounting (cable tie-included).

WSH-10

WINDSOCK HARDWARE



Hardware frame 10" throat complete with bolts and pipe collars



BA-16





1824-V | 1830-V | 1836-V | 2430-V | 2436-V

SOLID PVC FLAG



FABRIC HEAVY WEIGHT PVC/POLY/PVC WITH UV PROTECTION

SIZES

ITEM#	SIZE	DESCRIPTIONS
1824-V	18"x18"	VINYL FLAG, 24" DOWEL
1830-V	18"x18"	VINYL FLAG, 30" DOWEL
1836-V	18"x18"	VINYL FLAG, 36" DOWEL
2430-V	24"x24"	VINYL FLAG, 30" DOWEL
2436-V	24"x24"	VINYL FLAG, 36" DOWEL

Fluorescent orange color with wooden dowel. 3/4" diameter. 50 flags per case

1824-M | 1830-M | 2430-M

MESH PVC FLAG



FABRIC HEAVY WEIGHT MESH PVC

SIZES

ITEM#	SIZE	DESCRIPTIONS
1824-M	18"x18"	MESH FLAG, 24" DOWEL
1830-M	18"x18"	MESH FLAG, 30" DOWEL
2430-M	24"x24"	MESH FLAG, 30" DOWEL

Fluorescent orange color with wooden dowel. 3/4" diameter. 50 flags per case

OH18-C OVERHANG TRUCK FLAG



FABRIC 100% POLYESTER
SIZES 18" X 18"
COLOR RED

12.5 gauge with wire hanger. Not recommended for highway use. 50 flags per case

OH18-M MESH OVERHANG TRUCK FLAG



FABRIC 100% NYLON MESH
SIZES 18" X 18"
COLOR ORANGE

12.5 gauge with wire hanger. Suitable for highway use. 50 flags per case



RAIN WEAR
COLLECTION







7040-SD | 7040SD-OR

0.35MM HEAVY WEIGHT RAIN SUIT



FABRIC PVC REINFORCED WITH STRONG POLYESTER NET BACKING

SIZES S-5XL
COLORS YELLOW, ORANGE

Our most popular suit! 3-piece rain suit features jacket with detachable hood, storm-fly front with duracon snaps, and stand-up corduroy collar for extra comfort. Jacket has two flap pockets, underarm vents, and cape ventilated back. Bib overall has fly, adjustable sides and elastic suspenders. Take-up snaps at wrists and ankles



7040-SA

0.35MM HEAVY WEIGHT RAIN SUIT



FABRIC PVC REINFORCED WITH STRONG POLYESTER NET BACKING

SIZES S-5XL
COLORS YELLOW

Jacket has attached hood, storm-fly front with zipper, two flap pockets, underarm vents, and cape ventilated back. Bib overall has fly, adjustable sides, and elastic suspenders. Take-up snaps at wrists and ankles

7040-CD | 7040CD-OR

0.35MM HEAVY WEIGHT RAINCOAT



FABRIC PVC REINFORCED WITH STRONG POLYESTER NET BACKING

SIZES S-5XL (YELLOW), S-4XL (ORANGE)
COLORS YELLOW, ORANGE

Raincoat with detachable hood, storm-fly front with duracon snaps, and full corduroy collar for extra comfort. Coat has two flap pockets, underarm vents, and cape ventilated back. Take-up snaps at wrists



40-20 | 40-20BK

0.35MM FULL LENGTH RIDING COAT

FABRIC PVC REINFORCED WITH STRONG POLYESTER NET BACKING

SIZES S-4XL
COLORS YELLOW, BLACK



Long riding coat with unisex closure, detachable hood, storm-fly front with duracon snaps, and full corduroy collar for extra comfort. Coat has one outside flap pocket, one inside pocket, and cape ventilated back. Snaps on lower legs to prevent flapping



40-20BK

40-20

8050-SA

0.45MM EXTRA HEAVY WEIGHT RAIN SUIT

FABRIC PVC REINFORCED WITH STRONG POLYESTER NET BACKING

SIZES S-4XL
COLORS YELLOW



Jacket has attached hood and visor, storm-fly front with heavy duty zipper and duracon snaps. Bib overall has an inside pocket and quick release suspenders. Double reinforcements on elbows, knees, and crotch. Hook and loop adjustments at wrists, waist and ankles



7006-SD

0.10MM LIGHT WEIGHT RAIN SUIT

FABRIC 100% PVC

SIZES S-3XL
COLORS YELLOW



Jacket has detachable hood, snap front, underarm vents, and two flap pockets. Elastic waist pants. Take-up snaps at wrists and ankles



7010-VP

0.10MM VINYL PONCHO



FABRIC 100% VINYL

SIZES 50" W X 80" L
COLORS YELLOW, ORANGE, RED, PINK, NAVY BLUE, CLEAR, WHITE, OLIVE DRAB, CAMOUFLAGE

Heat sealed vinyl with full cut roomy hood and snaps on both sides



PE5080 | PE5080-CL

POLYETHYLENE EMERGENCY PONCHO



FABRIC 100% POLYETHYLENE

SIZES 50" W X 80" L
COLORS YELLOW, ORANGE, NAVY BLUE, OLIVE DRAB, CLEAR

Heat sealed with full cut roomy hood. Comes in individual packaging and 5 assorted colors per case. Sold in dozens only. (Item# PE5080-CL clear color only)

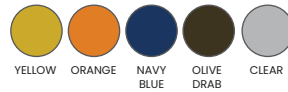

8035-CL

0.35MM CHEMICAL COVERALL



FABRIC DOUBLE COATED PVC ON REINFORCED NYLON NET BACKING

SIZES S-5XL
COLORS GREEN

Strong chemical protective coverall withstands a variety of acids and chemicals. Coverall has heat sealed seams, attached hood, and reinforcement on crotch. Double storm-fly front with full length zipper and duracon snaps. Self-material elastic inner cuffs in both sleeves and legs for extra protection. Flame retardant meets ASTM D6413. *Chemical testing report for coverall is available upon request



8035-SA 0.35MM CHEMICAL SUIT



FABRIC DOUBLE COATED PVC ON REINFORCED NYLON NET BACKING
SIZES S-4XL
COLORS GREEN

*Strong chemical protective suit withstands a variety of acids and chemicals. Suit has heat sealed seams, attached hood, and reinforcement on crotch. Double storm-fly front with zipper and duracon snaps. Self-material elastic inner cuffs in both sleeves and legs for extra protection. Flame retardant meets ASTM D6413. *Chemical testing report for suit is available upon request*



40-SDFR 0.25MM MEDIUM WEIGHT RAIN SUIT



FABRIC DOUBLE PLY LAMINATED PVC WITH SILVER LINING INSIDE
SIZES S-2XL, 4XL-5XL
COLORS YELLOW

Jacket has detachable hood, storm-fly front with duracon snaps, and two flap pockets. Underarm vents & cape ventilated back. Bib overall comes with fly, adjustable sides, and elastic suspenders. Take-up snaps at wrists and ankles

7040-SWH 0.35MM SOUTHWESTERN HAT



FABRIC PVC REINFORCED WITH STRONG POLYESTER NET BACKING
SIZES S-XL
COLORS YELLOW

Extra wide brim for nape protection

20

FE180 Emax



将
速

BOOTS
COLLECTION



SPT-16 | SST-16 PVC KNEE BOOTS



MATERIAL 100% PVC

TYPE SPT-16 PLAIN TOE, SST-16 STEEL TOE

SIZES PLAIN TOE 3-13, STEEL TOE 5-13

Two-stage injection molded construction for superior fit and comfort. Reinforced at critical stress points. Removable cushion insoles and anti-skid outer soles. 16" height. Steel toe meets ASTM F2413-11 testing

FB-14 FIVE BUCKLE ARCTIC RUBBER BOOTS



MATERIAL 100% RUBBER

SIZES 7-16

COLORS BLACK

Boots fit over the shoe. Full cut with extra wide last. Safe grip knurled sole and heel. Durable metal buckles adjust for perfect fit. Full knit lining. Non-skid sole. 14" height

YSB-17 SUPREME PULLOVER RUBBER SLUSH BOOTS



MATERIAL 100% RUBBER

SIZES 7-16

COLORS YELLOW

Boots fit over the shoe. Full cut with extra wide last. Safe grip knurled sole and heel. Rubber upper with full knit lining. Adjustable top straps. 17" height





**TARPS AND
FITTINGS**



PREMIUM FLAME RETARDANT TARP



FABRIC LAMINATED POLYETHYLENE,
SUPER STRENGTH, REINFORCED HDPE COLLAR

COLOR WHITE

Item #	Cut Size	Pkg/ctn
WF1020	10'x20'	5
WF1220	12'x20'	4
WF2020	20'x20'	2
WF2030	20'x30'	1
WF2040	20'x40'	1

14x14 mesh. 10 mil thickness. Made of laminated polyethylene. PE rope heat sealed in border. Rust resistant grommets approximately every 18 inches. Triple reinforced corners and double lock seams. Meets CPAI-84 Section 6 / NFPA-701 FR requirements

BLUE TEAR PROOF TARP



FABRIC LAMINATED POLYTHYLENE

COLOR BLUE

Item#	Cut Size	Pkg/Ctn
T 0507	5'x7'	25
T 0608	6'x8'	20
T 0810	8'x10'	15
T 0912	9'x12'	10
T 1012	10'x12'	10
T 1212	12'x12'	8
T 1214	12'x14'	8
T 1020	10'x20'	8
T 1216	12'x16'	8
T 1220	12'x20'	8
T 1620	16'x20'	4
T 1824	18'x24'	4
T 2030	20'x30'	2
T 2040	20'x40'	2

Made of laminated polyethylene. PE rope heat sealed in border. Rust resistant grommets approximately every 18 inches. Triple reinforced corners and double lock seams. Waterproof, tear proof, and mildew proof. Ideal for transportation, industrial, agricultural, marine, construction, ground cover, and utility usage

SUN SCREEN FABRIC

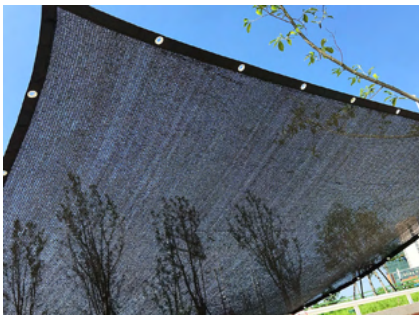

FABRIC 100% POLYETHYLENE, 75% SHADE

COLOR BLACK

Item #	Cut Size	Pkg/Ctn
BM75-0610	6'x10'	10
BM75-0620	6'x20'	5
BM75-1010	10'x10'	10
BM75-1020	10'x20'	5

Ideal shade screen for dendrobium orchids and most palms. Rust resistant grommets approximately every 18 inches. Use for greenhouse and plant shade. Creates shade, cools and reduces temperature. Privacy screen for patios, decks and fences. Breathable, will not trap heat. Wind screen for canopy tents. Blocks wind and sun

HEAVY DUTY TEAR PROOF TARP



FABRIC LAMINATED POLYTHYLENE

SILVER	Item#	Cut Size	Pkg/Ctn
	S 1010	10'x10'	8
	S 1012	10'x12'	8
	S 1016	10'x16'	6
	S 1020	10'x20'	5
	S 1220	12'x20'	4
	S 1620	16'x20'	3
	S 2020	20'x20'	2
	S 2030	20'x30'	1
	S 2040	20'x40'	1
	S 3030	30'x30'	1

WHITE	Item#	Cut Size	Pkg/Ctn
	W 1012	10'x12'	8
	W 1020	10'x20'	5
	W 1220	12'x20'	4
	W 2020	20'x20'	2
	W 2030	20'x30'	1
	W 2040	20'x40'	1

GREEN	Item#	Cut Size	Pkg/Ctn
	G 1010	10'x10'	8
	G 1020	10'x20'	5
	G 2020	20'x20'	2

Made of laminated polyethylene. PE rope heat sealed in border. Rust resistant grommets approximately every 18 inches. Triple reinforced corners and double lock seams. Waterproof, tear proof, and mildew proof. Ideal for transportation, industrial, agricultural, marine, construction, ground cover, and utility usage

EB-9 | EB-12 BALL BUNGIES



TYPE EB-9: 9" LONG, EB-12: 12" LONG
COLOR BLACK

Elastic ball ties designed to secure tarp to frame. 9" long or 12" long. 25 pieces per pack. Sold in packs only

CANOPY PEAK TYPE ROOF



Item: PR1020
CUT size: 10'x20'
Not Included:
13 pcs of 1"x10" long EMT Pipes

Item: PR2020
CUT size: 20'x20'
Not Included:
20 pcs of 1"x10" long EMT Pipes

Ideal for car/truck storage or shade for any occasion. Includes a waterproof, heavy duty silver tarp, fittings, and ball bungees

LOW PEAK ROOF CANOPY FITTINGS

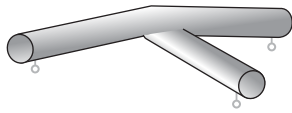
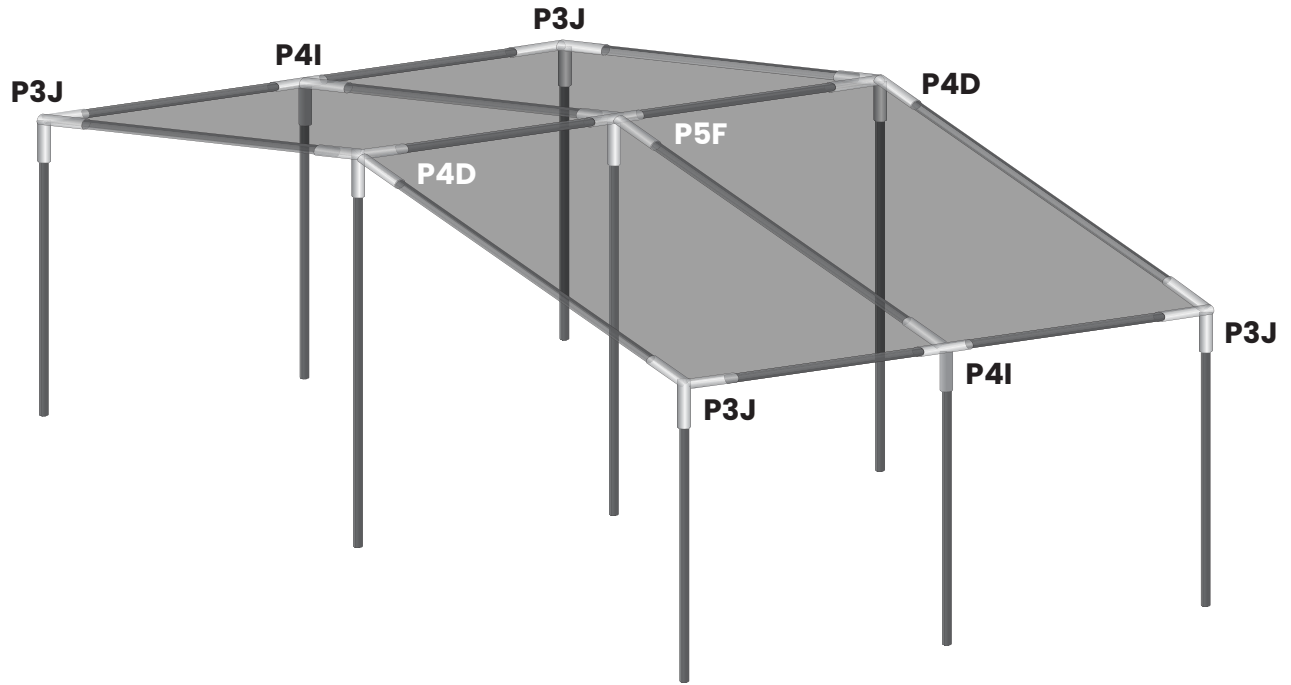

P3E
PEAK ROOF "TOP SIDE" 3-WAY FITTING

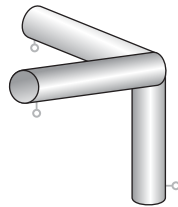

P3J
PEAK ROOF "CORNER" 3-WAY FITTING

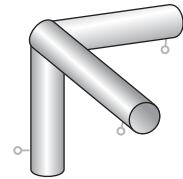

P3J-SLP
TOP SLOPE "CORNER" 3 WAY FITTING

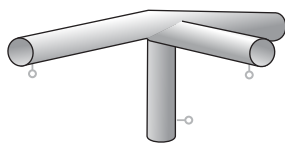

P4D
PEAK ROOF "TOP SIDE" 4-WAY FITTING

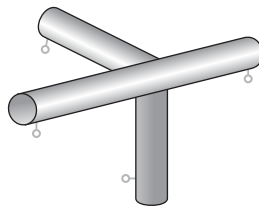

P4I
PEAK ROOF "SIDE EXT." 4 WAY FITTING

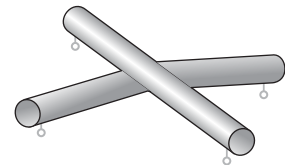

P4L
PEAK ROOF "CENTER" 4-WAY FITTING

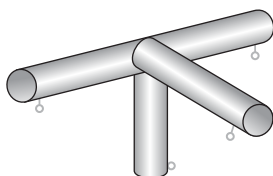

P4I-SLP
TOP SLOPE "SIDE EXT." 4-WAY FITTING

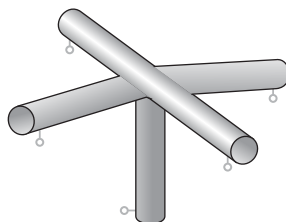

P5F
PEAK ROOF "CENTER" 5-WAY FITTING

Item#	Case
P3E	40
P3J	40
P3J-SLP	40
P4D	25
P4I	25
P4L	25
P4I-SLP	25
P5F	15

FLAT ROOF CANOPY FITTINGS

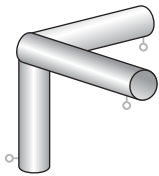
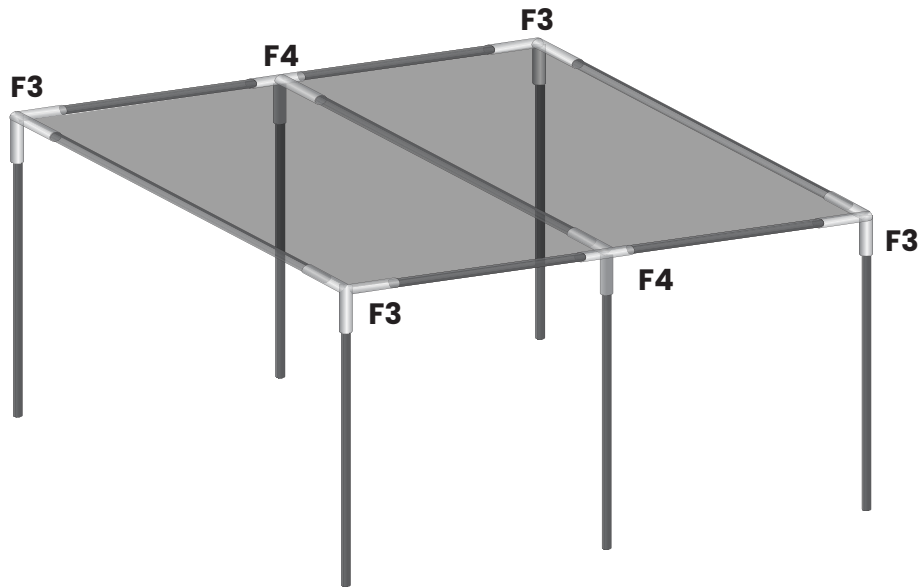

F3
FLAT ROOF "CORNER" 3-WAY FITTING

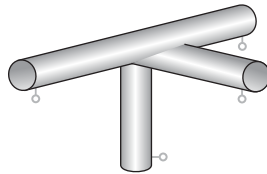

F4
FLAT ROOF "SIDE" 4-WAY FITTING

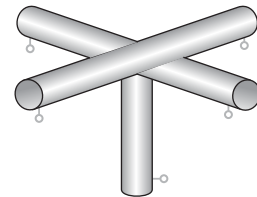

F5
FLAT ROOF "CENTER" 5-WAY FITTING



FC
CONNECTOR

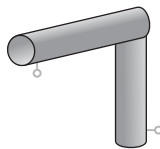

FL
FLAT ROOF "90 DEG." 2-WAY FITTING

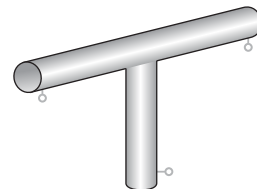

FT
FLAT ROOF "SIDE" 3 WAY FITTING

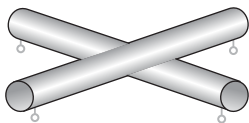

FX
FLAT ROOF "CENTER: 4-WAY FITTING

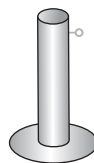

FP4.5
FOOT PAD, 4.25" DIA

Item#	Case
F3	40
F4	25
F5	15
FC	60
FL	40
FT	40
FX	25
FP4.5	12



EST.

1982

2W INTERNATIONAL

CONCERN FOR YOUR SAFETY

